

# Quantification of Power Quality Issues at the PV Panel-Converter Interface

M. Andrejević Stošović, M. Dimitrijević, V. Litovski  
University of Niš, Faculty of Electronic Engineering  
Niš, Serbia  
(miona.andrejevic, marko.dimitrijevic,  
vanco.litovski)@elfak.ni.ac.rs

D. Lukač  
Rheinische Fachhochschule  
Köln, Deutschland  
lukac@rfh-koeln.de

**Abstract**— Power quality issues are of interest for a long period of time. Main research and definitions, however, are produced for AC power systems. Here we try to quantify the power quality issues at the PV panel - converter interface. Namely, due to the switching in the converter (or inverter) and due to the finite output resistance of the PV panel, time varying components of the output voltage and current of the PV panel are present being larger for lower irradiance. Their spectral component having the lowest frequency is much above the reach of the MPP control circuitry so leaving a problem to be taken into account in the PV system design suit. Terms as voltage and current ripple factor, total power, total power factor, AC power, and balance factor are introduced. Their values, for one panel, are extracted by simulation. Dependences of these quantities on the photocurrent are presented confirming their importance in low irradiance cases.

**Keywords**- PV panel, Converter, Voltage ripple factor, Current ripple factor, Total power, Total power factor, AC power, Balance factor.

## I. INTRODUCTION

Power quality issues are of serious concern for long period of time [1]. Main attention, naturally, was devoted to the main electricity distribution systems. With the advent of the distributed generation and especially the alternative energy sources, however, new issues were to be considered. The number of new loads, mainly electronic systems, has risen dramatically exposing the harmonic distortions related to nonlinear loads [2]. In addition, penetration of renewable energy sources to the grid introduced issues of interaction with the grid which all led to needs for new standardization activities in order to encompass the subject more completely [3].

Among the alternative energy sources the photovoltaic (PV) technology is one of the most promising [4]. It is expected that PV will play a significant role in meeting the world's future energy demand. In this technology sources of DC voltage are driving converters and (or) inverters which are implemented for energy transmission from the source to the load. Power quality problem genesis and principal concerns in such implementations were qualitatively discussed in [5]. While the problem of power quality at the AC side of the system e.g. the output of the inverter, is much more elaborated in the literature [6], the DC side is frequently characterized with much less attention especially when the input of a DC to DC converters are sought. In fact, attention is paid to the input of the con-

verter in order to create design rules and quality measures for implementation of the maximum power point tracking [7] [8].

The specifics of the power quality issues here are related to the characterization of a DC voltage, current, and power in terms of the time varying component being the consequence of the switching within the converter, not as a consequence of MPP tracking. Namely the former is of much higher frequency and is out of reach of the MPP tracking technology. There is a practice to define the quality of AC quantities by expressing the properties of the AC voltage, AC current and the corresponding power quantities. To our knowledge, however, no formal definitions of quality parameters of the DC power quantities are presented until now.

It was our intention in [9] to put some more light to the electrical interface between the PV system and the DC/DC converter which is first encountered in the transmission chain. It was shown by simulation that, due to the commutations within the converter and the finite output resistance of the PV panel, the output voltage of the PV system by no means is as simple as a DC voltage. In practice a large valued capacitor named line capacitor is frequently used to mitigate the problem. The properties of such large electrolytic capacitors were exposed, however, to show that inductive behavior may be expected at the harmonic frequencies of the controlling signal of the converter so compromising its role.

These considerations were confirmed by measurements in [10]. It was shown that there exists a time dependent component of the voltage (and current) at the PV panel-converter interface which is dependent on the insolation of the panel. For low insolations i.e. at cloudy days, large amplitudes of the AC components of the interface voltage (and current) were measured. The time dependent component is simply there, heating the cell, and one is to have in mind its presence and search for design methods to reduce it as a supplement to the frequently used panel positioning techniques (tracking systems). Improving the harvesting of solar energy on cloudy days deserves wider attention as stated in [11]. Especially, "increasing the output of distributed solar power systems on cloudy days is important to developing solar powered home fuelling and charging systems for hydrogen-powered fuel-cell electric and battery-powered vehicles, respectively, because it reduces the system size and cost for solar power systems that

are designed to have sufficient energy output on the worst (cloudy) days".

It is our intention here to give some definitions of the electrical quantities at the PV panel-converter interface. Data will be produced based on repetitive simulation of a PV panel driving a converter being loaded by resistive load. Terms as voltage and current ripple factor, total power, total power factor, AC power, and balance factor will be introduced. Their values, for one panel, were extracted by simulation. Dependences of these quantities on the photocurrent will be presented confirming their importance in low insolation cases.

The paper is organized as follows. In the second paragraph, the common nonlinear dynamic model of a solar cell will be introduced first. An equivalent Norton source will be extracted in order to simplify the proceedings. In the third paragraph a simplified model of the interface between the PV panel and the DC/DC converter will be created in which the so called link (electrolytic) capacitor and its model will be inserted. Simulation will be performed with a reduced resistive model of the PV panel to get the notion on the voltage waveform at the interface. The spectrum of the voltage at the interface will be produced in order to get notion about the frequency band that is to be considered in evaluation the properties of a PV panel. All that was conceived to confirm the existence of the time variable component at the interface. Paragraph IV represents the main contribution of the paper. Repetitive simulations will be performed with various values of the photocurrent that was used to represent the insolation of the cells. Quantitative properties of the interface in a realistic ambient will be obtained by simulation of the complete panel and converter with adjustment of the duty cycle of the switching signal to emulate the maximum power point tracking. Definitions will be proposed for the voltage and the power at the interface and their dependence on the insolation will be studied. Dependences of the newly introduced quantities on the photocurrent will be given.

## II. PV CELL MODEL USED

A function of a PV cell is simple: it absorbs photons from sunlight and releases electrons, so when there is a load connected to the cell, electric current will flow. PV cells are based on a variety of light-absorbing materials, including monocrystalline silicon, polycrystalline silicon, amorphous silicon, thin films such as cadmium telluride (CdTe) and copper indium gallium selenide (CIGS) materials, and organic/polymer-based materials.

A PV cell is usually represented by a light-induced current source,  $I_P$ , in parallel with a diode, as shown in Figure 1. [12]. The output of the current source is proportional to the light flux (power per unit area) falling onto the cell. The diode determines the I-V characteristics of the cell. Because of material defects and ohmic losses in the cell substrate material as well as in its metal conductors, surface, and contacts, the PV cell model also must include series ( $R_s$ ) and shunt ( $R_{sh}$ ) resistance, respectively, to account for these losses.  $R_s$  is a key parameter because it limits the maximum available power ( $P_{max}$ ) and the short-circuit current ( $I_{SC}$ ) of the PV cell.

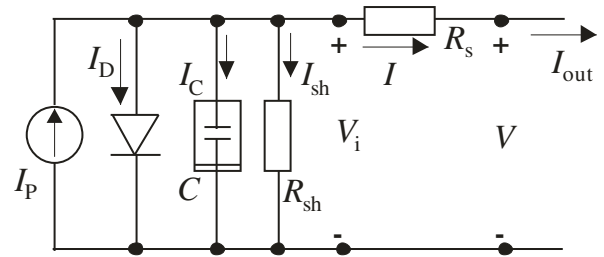

Figure 1. The PV cell model

The  $R_s$  of the PV cell may be due to the resistance of the metal contacts on the cell, ohmic losses in the front surface of the cell, impurity concentrations, or junction depth. Hence its nonlinearity. Under ideal conditions,  $R_s$  would be 0  $\Omega$ . The  $R_{sh}$  represents the loss due to surface leakage along the edge of the cell or crystal defects. Under ideal conditions, it would have an infinite value and in most of the literature it is neglected in order to simplify the electrical model. But, in [7] it is shown that at very low irradiances, its value increases dramatically, i.e. the contribution of the apparent shunt resistance is only significant for cell voltages below about 0.45 V, and depends on irradiance. For the purpose of simulation the following parameters of the model will be implemented [13], [14]:  $I_0=0.3223 \mu\text{A}$ ,  $n=1.4837$ ,  $R_s=0.0364 \Omega$ ,  $R_{sh}=53.76 \Omega$ ,  $C_{t0}=354 \text{ nF}$ ,  $V_0=0.73 \text{ V}$ , and  $C_{d0}=2.43 \cdot 10^{-15} \text{ F}$ , where  $C_t$  stands for the junction capacitance while  $C_d$  represents the diffusion capacitance.  $V_0$  is the junction barrier. Throughout the paper the photocurrent  $I_P$  will be used as a measure of the absorbed energy. It may be converted into power per area by using  $I_P=C_{ph} \cdot P/S$ , where  $P/S$  is the incident power per unit area and  $C_{ph}$  is the proportionality constant of generated photocurrent which is, according to [15]:  $C_{ph}=3.7734^{-3} [\text{m}^2/\text{V}]$ .

The electrical properties of the cell as a function of the ambient irradiance are captured within the expression of  $I_P$  while the cell temperature influence is mainly expressed through temperature dependence of the diode current.

The PV cell characteristics under steady state conditions are depicted in Fig. 2. Two diagrams are shown: the I-V and the P-V characteristic. Based on these the main parameters of the PV cell e.g.  $I_{SC}$  (the short-circuit current),  $V_{OC}$  (the open-circuit voltage),  $V_{mpp}$  (the voltage at maximum power), and  $I_{mpp}$  (the current at maximum power), may be recognized.

The dynamic properties of the PV cell are related to the capacitances of the diode. These are the junction capacitance that is dominant at voltages below and about MPP, and the diffusion capacitance that takes over at high diode currents.

So, having in mind the notation of Fig. 1, the following nodal equations may be written

$$\begin{aligned} I_D + I_{sh} + I + I_C &= I_P \\ -I + I_{out} &= 0. \end{aligned} \quad (1)$$

$I_{out}$  is the load current (Most frequently  $I_{out}=V/R_L$ , where  $R_L$  is the load resistance). All,  $I_D$ ,  $I_{sh}$ ,  $I_C$ , and  $I$  may represent

models of nonlinear voltage controlled elements.  $I_P$  is here considered as voltage independent. In some cases however, it may be voltage dependent as shown in [16].

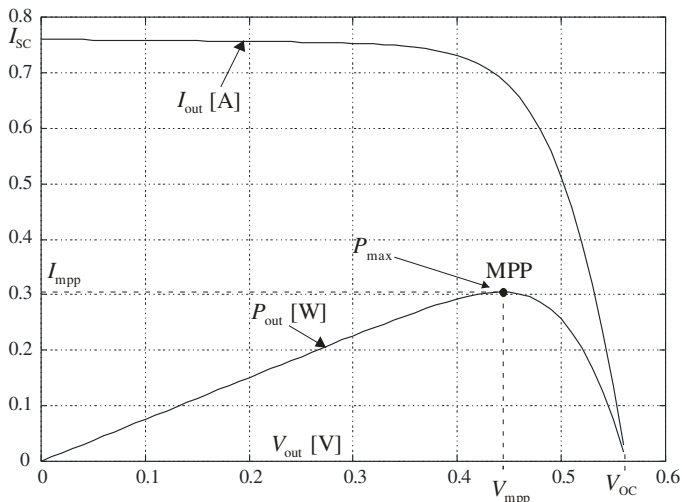

Figure 2. The steady state characteristics of a PV cell

For the most frequent case, when linear  $R_s$  and  $R_{sh}$  are assumed, one may use the following nodal equations

$$I_D + \frac{V_i}{R_{sh}} + \frac{1}{R_s}(V_i - V) + I_C = I_L \quad (2)$$

$$\frac{1}{R_s}(V - V_i) + I_{out} = 0$$

where

$$I_D = I_0(e^{\frac{qV_i}{n k T}} - 1), \quad (3)$$

$$I_C = \frac{dQ_C}{dt} = (C_t + C_d) \cdot \frac{dV_i}{dt} \quad (4)$$

and:  $q$  is the charge of electron;  $k$  is the Boltzmann constant;  $T$  is the cell temperature;  $I_0$  is the diode saturation current; and  $n$  is the p-n junction's ideality factor.  $C_t$  stands for the junction capacitance while  $C_d$  represents the diffusion capacitance.

Using this concept, if model parameters available, simulation of photovoltaic systems containing virtually unlimited number of PV cells and electronic circuitry of any complexity may be simulated using standard electronic circuits analysis methods [17,18].

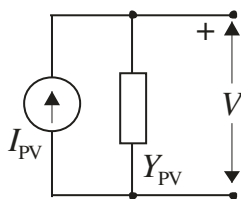

Figure 3. A nonlinear model of the PV system

The output circuitry of a PV system (and PV cell), as complex as it can be [19], may be modeled as a current source  $I_{PV}$

(equivalent Norton) with internal admittance  $Y_{PV}$  as shown in Fig. 3. Note the admittance is to be nonlinear since it represents the nonlinearities of the diode(s), the junction capacitance(s) and the resistances. This configuration is to be opposed to the voltage source model used in some research papers [20, 21]. In our opinion the current source model is more natural since it resembles the inner structure of the solar cell. Here, however, for now, the purpose of modeling is to get a rough picture of the PV system-converter interface and no details will be given about the nonlinear PV-model parts.

### III. THE CONVERTER AND SIMPLIFIED MODELING THE COMPLETE SYSTEM

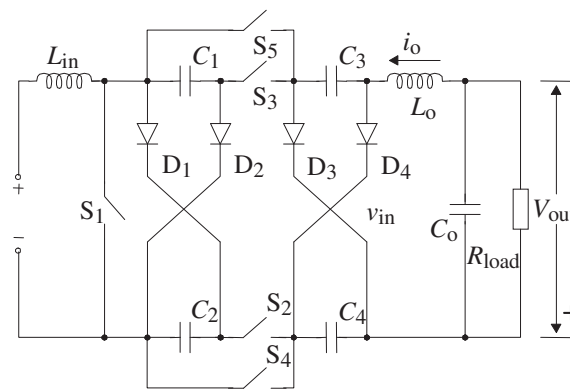
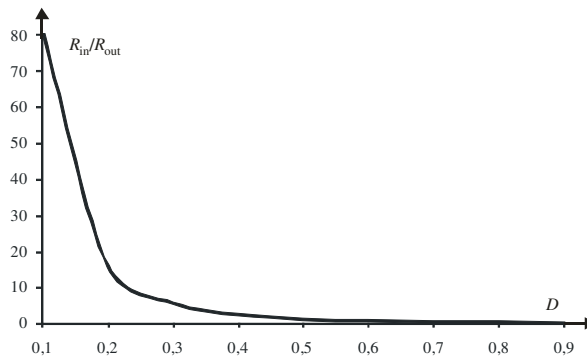

Figure 4. The Ćuk converter

The PV panel, in most cases, is driving a DC to DC converter. One, among many, variant of a converter is the Ćuk converter [22, 23] shown in Fig. 4. Here constant voltage excitation is assumed while the switching frequency is 50 kHz. For these proceedings, however, since the converter is excited by a PV panel, the input voltage  $v_{in}$  of the converter is unknown. The following element values and model parameters for the components were used for the simulation in these proceedings:  $C_1=C_2=C_3=C_4=22 \mu\text{F}$ ,  $C_0=1 \mu\text{F}$ ,  $L_{in}=600 \mu\text{H}$ ,  $L_o=600 \mu\text{H}$ ,  $D_1=D_2=D_3=D_4=DFLS220L$ , and  $S_1=S_2=S_3=S_4$  with  $R_{on}=0.001 \Omega$ ,  $R_{off}=1000 \text{M}\Omega$ , and  $V_T=0.5 \text{V}$ .

The input resistance of the basic configuration of the Ćuk converter is shown in [24] to be

$$R_{in} = [(1 - D)^2 / D^2] \cdot R_{load} \quad (5)$$



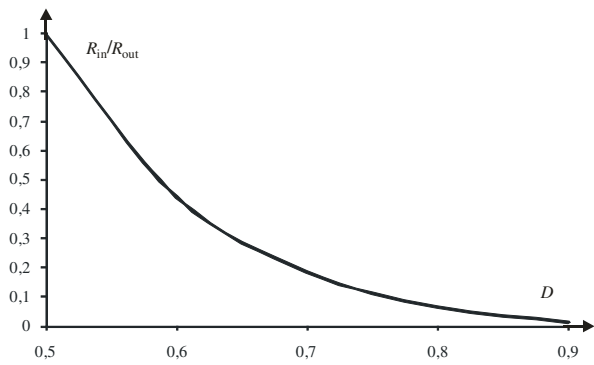

Figure 5. Normalized input resistance of the converter as a function of the duty cycle

$D=0.75$ , and  $R_{load}=115.52 \Omega$  was used for the simulation in this paragraph only. Normalized input resistance of the converter as a function of the duty cycle is depicted in Fig. 5.

The simplified schematic of the complete system is depicted in Fig. 6a. Here for simplicity  $Y_{pv}$  is neglected and  $I_{pv}=17.5 \text{ A}$  is used. A link capacitor  $C_{pv}=1 \text{ mF}$  is inserted at the interface. Its model is depicted in Fig. 6b.

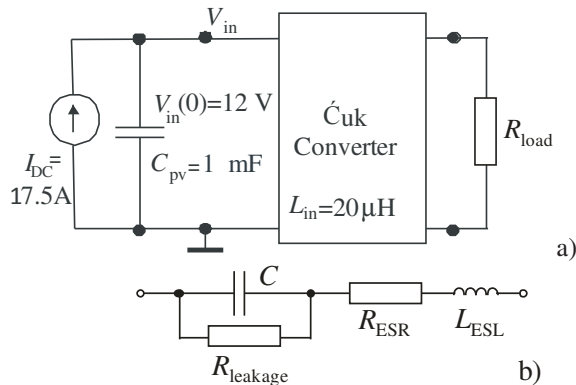

Figure 6. a) Simplified model of the PV system used to excite the Ćuk converter with large capacitance in between. b) Model of the electrolytic capacitor ( $C_{pv}$ ):  $C=1 \text{ mF}$ ,  $R_{leakage}=1 \text{ M}\Omega$ ,  $R_{ESR}=0.5 \Omega$ , and  $L_{ESL}=3 \text{ nH}$ .

The switching frequency, the line capacitance and the inductor value are to be selected for the best performance considering conversion efficiency, cost and power consumption. For example, the higher the switching frequency, the lower the inductor and the capacitance size, but also the tracker power consumption and losses are higher. On the other hand, larger capacitances decrease the responsiveness of the harvester to fast variations of environmental irradiance.

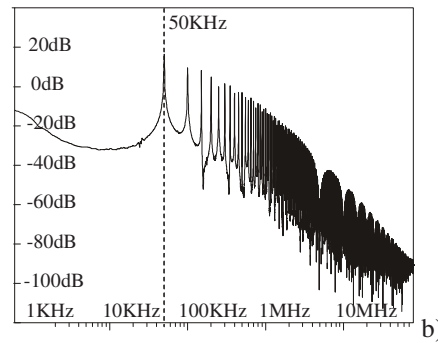
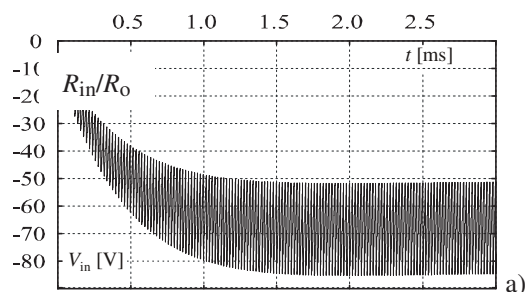

Figure 7. a) The input voltage of the circuit of Fig. 6a, b) Spectrum of the input voltage

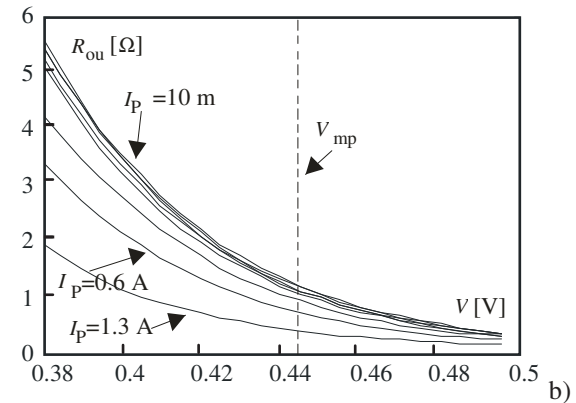
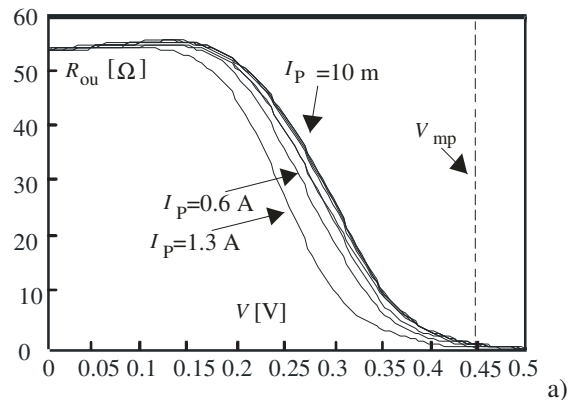

Figure 8. Small signal output resistance of a PV cell as a function of the cell voltage with the photocurrent as parameter

The simulation results are shown in Fig. 7a. As can be seen, alternating component of amplitude larger than 20% of the DC voltage value is obtained despite the presence of a capacitor with large capacitance. The spectrum of the input voltage is depicted in Fig. 7b. It shows presence of significant amount of harmonics.

Even in more realistic situations when the output impedance of the converter is not considered infinite, for lower values of the irradiance, this phenomenon will be still present. The reason for that is the rise of the output resistance of the PV cell at low irradiances as depicted in Fig. 8. Here the small signal output resistance of a PV cell (model parameters as above) is depicted as a function of the cell voltage for different values of the photocurrent. Note, change of the input resistance of the converter by the MPP tracker leads to power transfer accom-

modation from the DC point of view. The AC voltage at the interface is raised when the output resistance of the panel is risen due to the proper voltage drop.

The PV panel was constructed of 18 cells connected in two parallel columns with 9 cells in series each. Accordingly, under the presumption of identical cells, the total small signal output resistance of the panel may be obtained by multiplying the y-axis of Fig. 8 by 4.5.

#### IV. QUANTIFICATION OF POWER QUALITY ISSUES

To get a realistic representation of the properties of the PV panel - converter interface we here introduce several definitions. In that way evaluation of the quality of the interface will be enabled. To do that we use the above mentioned panel. For a set of values of the photocurrent the optimum value of the duty cycle was adjusted to a value, so that the input resistance of the converter is equal to the equivalent output resistance of the solar panel at the MPP. For that value the voltage and current at the interface were produced by simulation in time domain. Fig. 9 depicts the steady state current voltage relationship for a large value of the photocurrent. Similarly, Fig. 10 represents the average value of the instantaneous power in steady state. Based on these simulations the following is introduced.

Let the measured waveforms at the PV panel-converter interface be the voltage  $v(t)$  and the current  $i(t)$ .

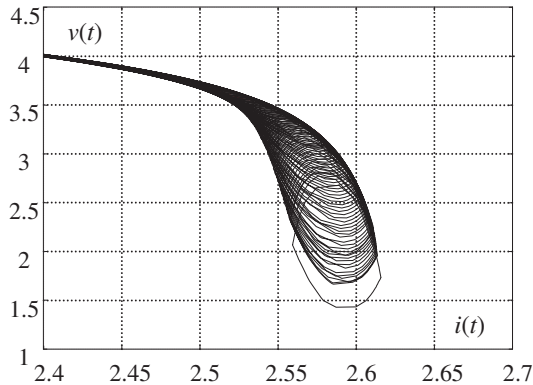

Figure 9. Chaotic diagram representing the current voltage relationship at the PV panel - converter interface for  $I_p=1.3$  A

We define the DC components of the voltage and current as

$$V_{DC} = \frac{1}{kT} \int_{\tau}^{\tau+kT} v(t) dt \quad (6)$$

and

$$I_{DC} = \frac{1}{kT} \int_{\tau}^{\tau+kT} i(t) dt . \quad (7)$$

Here  $k$  is to be kept as small as possible. It would be the best to have  $k=1$  but since the sampling usually does not match exactly the period, to reduce the numerical error, one should use a slightly larger value,  $k=3$  for example.

We define the voltage ripple factor as

$$r_v = 100 \cdot V_{AC\ m\ tot} / V_{DC} [\%], \quad (8)$$

where  $V_{AC\ m\ tot} = \sqrt{\sum V_{AC\ m\ i}^2}$ , while  $V_{AC\ m\ i}$  is the amplitude of the  $i$ th harmonic of  $v(t)$ . As the first harmonic the one having the frequency of the switching signal is considered.

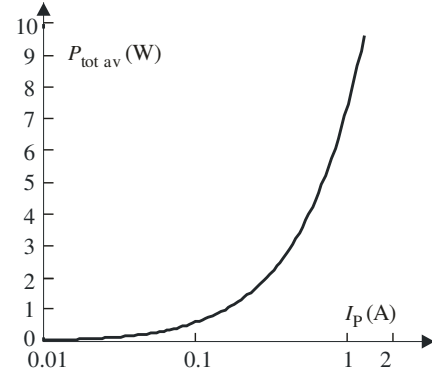

Figure 10. Average value of the instantaneous power in steady state at MPP as a function of irradiation (here represented by the photocurrent)

Similarly we define the current ripple factor as

$$r_i = 100 \cdot I_{AC\ m\ tot} / I_{DC} [\%], \quad (9)$$

where  $I_{AC\ m\ tot} = \sqrt{\sum I_{AC\ m\ i}^2}$ , while  $I_{AC\ m\ i}$  is the amplitude of the  $i$ th harmonic of  $i(t)$ . The dependence of  $r_v$  and  $r_i$  on the photocurrent under optimal power transfer conditions is depicted in Fig. 11.

The average of the total power is obtained from

$$P_{tot\ av} = \frac{1}{kT} \int_{\tau}^{\tau+kT} v(t) \cdot i(t) dt , \quad (10)$$

while the DC power is

$$P_{DC} = I_{DC} \cdot V_{DC} \quad (11)$$

Fig. 12 depicts  $P_{tot\ av}$  as function of the illumination. The residue is defined by the difference:

$$P_{res\ tot} = P_{tot\ av} - P_{DC}. \quad (12)$$

This will be referred to as residual total power.

This is an important quantity representing the energy heating the PV panel with no positive effects in the energy balance.

The AC components of the voltage and current at the PV panel-converter interface are defined as

$$v_{AC}(t) = v(t) - V_{DC} \quad (13a)$$

$$i_{AC}(t) = i(t) - I_{DC} \quad (13b)$$

These definitions allow for computation of the average power related to the AC components only:

$$P_{AC} = \frac{1}{kT} \int_{\tau}^{\tau+kT} v_{AC}(t) \cdot i_{AC}(t) dt . \quad (14)$$

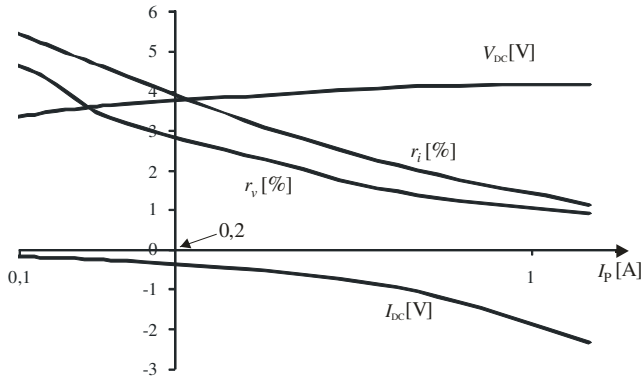

Figure 11. The voltage ripple factor ( $r_v$ ), the current ripple factor ( $r_i$ ), the DC voltage ( $v_{DC}$ ) and the DC current ( $i_{DC}$ ) of the PV panel as a function of irradiance (here represented by the photocurrent). MPP (optimum duty cycle) kept for every value of  $I_p$ .

It will be referred to as AC power. Substituting for  $v_{AC}(t)$  and  $i_{AC}(t)$  we get

$$P_{AC} = P_{tot av} - \frac{V_{DC}}{kT} \int_{\tau}^{\tau+kT} i(t) dt - \frac{I_{DC}}{kT} \int_{\tau}^{\tau+kT} v(t) dt + P_{DC} =$$

$$= P_{tot av} - P_{DC} = P_{res tot} \quad (15)$$

Having this result in mind, from now on, we will use the AC power only as the quantity defining energy balance.

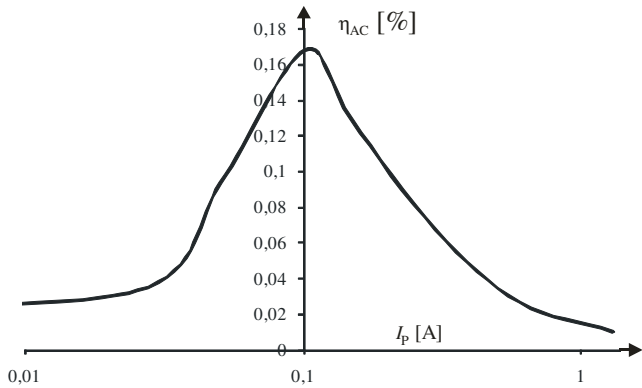

Figure 12.  $\eta_{AC}$  as a function of  $I_p$  at MPP

The AC power factor as

$$\eta_{AC} = 100 \cdot P_{AC} / P_{tot av} [\%] \quad (16)$$

Its value for ideal conditions should be zero.

The dependence of this quantity on the photocurrent is depicted in Fig. 12. One may observe that the largest value is obtained at very low irradiances. Note the absolute value is small, almost negligible, what is a consequence of the fact that PAC is obtained as a product of the AC components that

constitute small amount of their DC counterparts as can be seen from Fig. 11.

Finally, we define the balance factor as

$$C = 1 - P_{AC} / P_{DC} . \quad (17)$$

Its value under ideal conditions should be equal to unity.

## CONCLUSION

Terms such as voltage and current ripple factor, total power, total power factor, ac power, and balance factor were introduced, and computed for a given pv panel - converter interface. Their values were extracted by simulation. Dependences of these quantities on the photocurrent were presented confirming their importance in low irradiance cases. A general conclusion may be drawn that the importance of the harmonic components come into fore when characterizing the voltage and current at the interface. Due to the multiplication of two relatively small quantities (AC components of the voltage and current) the AC power component at the interface is not of great importance.

## ACKNOWLEDGMENT

This research was partly funded by The Ministry of Education and Science of Republic of Serbia under contract No. TR32004.

## REFERENCES

- [1] Dugan, R.C., et al., "Electrical Power Systems Quality", McGraw-Hill, New York, NY, 2003.
- [2] Heydt, G.T., "Electric Power Quality", Stars in a Circle, West LaFayette, In., USA, 1991
- [3] IEEE Power Engineering Society, "IEEE Trial-Use Standard Definitions for the Measurement of Electric Power Quantities under Sinusoidal, Nonsinusoidal, Balanced, or Unbalanced Conditions, IEEE Std. 1459-2010, Feb. 2010.
- [4] OECD/IEA, "Technology Roadmap, Solar photovoltaic energy", International Energy Agency, 2010
- [5] Maglin, J. R., and Ramesh, R., "Power Quality Issues in Solar Converters: A Review", European Journal of Scientific Research, Vol.61, No.2, 2011, pp. 321-327.
- [6] Khadem, S.K., Basu, M., and Conlon, M.F., "Power quality in a grid connected renewable energy systems: role of custom power devices", Proc. of the Int. Conf. on Renewable Energies and Power Quality, ICREPQ'10, Granada Spain, March 2010.
- [7] Shu-Hung Chung, H., et al., "A Novel Maximum Power Point Tracking Technique for Solar Panels Using a SEPIC or Cuk Converter", IEEE Trans. On Power Electronics, Vol. 18, No. 3, May 2003, pp. 717 - 724.
- [8] Hobraiche, J., et al., "A New PWM Strategy to Reduce the Inverter Input Current Ripples", IEEE Trans. on Power Electronics, Vol. 24, No. 1, Jan. 2009, pp. 172-180.
- [9] Andrejević Stošović, M., Lukač, D., and Litovski, V., "Realistic Modeling and Simulation of the PV System - Converter Interface", Proc. of the 4<sup>th</sup> Small Systems Simulation Symposium, SSSS2012, Niš, Serbia, ISBN 978-86-6125-059-0, pp. 28-32.
- [10] Dimitrijević, M., Andrejević Stošović, M., and Lukač, D., "Experimental Characterization of the PV Panel - Converter Interface", Proc. of the 56<sup>th</sup> Conf. of ETRAN, Zlatibor, Serbia, June 2012, EL 4.3.

- [11] Kelly, N.A. and Gibson, T.L., "Increasing the solar photovoltaic energy capture on sunny and cloudy days", *Solar Energy*, Vol. 85, 2011, pp. 111–125.
- [12] Yordanov, G. H., Midtgård, O.-M., "Physically-consistent Parameterization in the Modeling of Solar Photovoltaic Devices," *PowerTech*, 2011, Trondheim, Norway, pp. 1-4.
- [13] Chegaar, M., et al., "Determination of Solar Cells Parameters under Illuminated Conditions", *Journal of Electron Devices*, Vol. 2, 2003, pp. 17-21.
- [14] -, "Electrical Characterization of Photovoltaic Materials and Solar Cells with the Model 4200-SCS Semiconductor Characterization System", Keithley, Application Notes No. 3026 and No. 2876, 2010. <http://www.compadre.org/advlabs/tcal/Detail.cfm?id=2813>.
- [15] Lindgren, B., "A Power Converter for Photovoltaic Applications", Technical Report No. 335L, Submitted to the School of Electrical and Computer Eng., Chalmers Uni. of Technology, Dept. of Electric Power Eng., Göteborg, Sweden, February, 2000.
- [16] Chen, C., et al., "Analytical model for the photocurrent-voltage characteristics of bilayer MEH-PPV/TiO<sub>2</sub> photovoltaic devices", *Nanoscale Res. Lett.* 2011, Vol. 6, No. 1, pp. 350- 367.
- [17] Litovski, V., Zwolinski, M., "VLSI circuit simulation and optimization," Chapman and Hall, 1997.
- [18] Castaner, L., Silvestre, S., "Modelling Photovoltaic Systems Using PSpice", Wiley, 2003.
- [19] Sulaiman, S.I., Abdul Rahman, T.K., and Musirin, I., "Partial Evolutionary ANN for Output Prediction of a Grid-Connected Photovoltaic System," *Int. J. of Computer and Electrical Engineering*, Vol. 1, No. 1, April 2009, pp. 40-45.
- [20] Tse, K. K., et al., "A Novel Maximum Power Point Tracker for PV Panels Using Switching Frequency Modulation", *IEEE Trans. on Power Electronics*, Vol. 17, No. 6, Nov. 2002, pp. 980-989.
- [21] Kim, D., Son, D., and Choi, B., "Input Impedance Analysis of PWM DC-to-DC Converters", Twenty-First Annual IEEE Applied Power Electronics Conf. and Expo., 2006. APEC '06, Dallas, Texas, March 2006, pp. 1339-1346.
- [22] Ćuk, S., Middlebrook, R. D., "A General Unified Approach to Modelling Switching-Converter Power Stages", *Proc. of the IEEE Power Electronics Specialists Conf.*, Cleveland, OH., June 8, 1976, pp.73–86.
- [23] Ćuk, S., and Middlebrook, R.D., "A New Optimum Topology Switching DC-to-DC Converter", *PESC'77 Record*, 1977, pp.160-179
- [24] Oi, A., "Design And Simulation of Photovoltaic Water Pumping System", Master Thesis at The Faculty of California Polytechnic State University, San Luis Obispo, 2005.